



Compact Size Photosensor Z Series

(LED Type : For General Use)

ZT series	Thru-Beam
ZR series	Retro-reflective
ZR-Q series	Retro-reflective for glass / transparent object detection
ZD series	Diffuse Reflective
ZD-W series	Divergent
ZD-L series	Convergent
BGS-Z series	BGS sensing

(LED Type : Coaxial Beam)

ZR-X series	Retro-reflective, coaxial optics
ZR-QX series	Retro-reflective, coaxial optics for glass / transparent object detection

(Laser Type : Fine Spot)

ZT-L series	Thru-Beam
ZR-L series	Retro-reflective
ZD-L series	Diffuse Reflective
BGS-ZL series	BGS sensing

<http://www.optex-fa.com>

Compact size photoelectric sensors, with LED,
Coaxial LED or Laser light source.

Seven different sensing types for the maximum flexibility in any application.

- Specifications and technical information not mentioned here are written in Operation Manual. Or visit our website for details.
- All the warnings and cautions to know prior to use are given in Operation Manual.





Laser Type

- 30 meter sensing distance (Thru-beam type), fast 250 μ sec. response time.
- Compact size with Laser source, small 2 mm diameter projected beam.
- IP67 rating
- M8 QD types are available

Z-L Series

The Laser light source projects a 2 mm spot at 400 mm distance (Diffuse mode). BGS (Background Suppression) sensing is also available in the BGS-ZL series.



Thru-beam type, ZT-L series

30mm spot size at 30 meter sensing distance

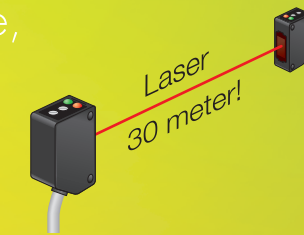

250 μ sec response

Good for fast moving objects.

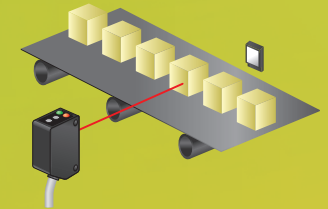

Diffuse Reflective, ZD-L type

Fine 2mm spot at 400mm sensing distance

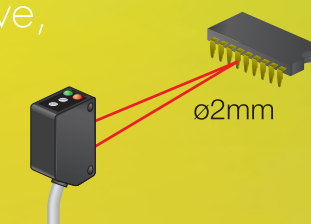

Cross-talk prevention

2 sensors can be mounted side-by-side.



Retro Reflective, ZR-L type

10mm spot size at 10 meter sensing distance

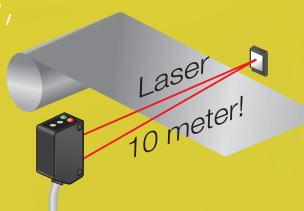

IP67 rating

Hose it down! Water-tightness is tested to IP67.



Z Series

A large product family designed with both standard and coaxial LED light sources. A coaxial LED light source enables exact positioning to the target. Optex-FA specializes in the detection of transparent glass and plastic, two different models of transparent detection sensors are available in this compact body style.



Specification

Model	Thru-beam	Polarized Retro-reflective	Diffuse-reflective	
Cable Type	NPN	ZT-L3000N	ZR-L1000N	ZD-L40N
	PNP	ZT-L3000P	ZR-L1000P	ZD-L40P
M8 connector type	NPN	ZT-L3000CN	ZR-L1000CN	ZD-L40CN
	PNP	ZT-L3000CP	ZR-L1000CP	ZD-L40CP
Supply voltage	DC10~30V Inc. 10% ripple			
Current consumption	30mA max.	20mA max.		
Sensing range	30meter	10meter (Reflector : P250F)	400mm	
Spot size	30mm/30m	10mm/8m	2mm/400mm	
Response time	0.25ms			
Hysteresis	-			
Operating temp.	-10 to +50°C			
Operating humidity	35 to 85%			
Storage temp./humidity	-25 to +70°C/35 to 95%			
Vibration Resistance	10 to 55Hz width 1.5mm			
Shock Resistance	50 G (500 m/s ²)			
Protection category	IP67			
Light Source	Laser (650nm)			
Laser class (IEC)	class 1	class 2		
Laser class (FDA)	class I	class II		
Output Indicator	Orange(Yellow) LED			
Laser Power Indicator	Green LED			
Sensitivity adjustment	Single turn potentiometer			
Output Operation	Light On / Dark On selectable (switch)			
Connection	2m cable / M8 connector			

Specifications are subject to change without prior notice.

BGS - Laser Type

Fine spot / high speed applications



BGS - LED Type

General purpose applications



- BGS (Background Suppression Type) Sensors are not influenced by the background, available with conventional LED or Laser light source.
- 250 μ sec fast response (Laser light source models)
- 1 mm projected spot size with BGS optical system (BGS-ZL Laser types)

1 mm projected spot size

The Short distance BGS Laser sensor projects a very small ϕ 1 mm spot at 100 mm distance. Ideal for the detection of small targets at long distance without being influenced by the background. The Long distance type projects a ϕ 1.5 mm spot at 300 mm.

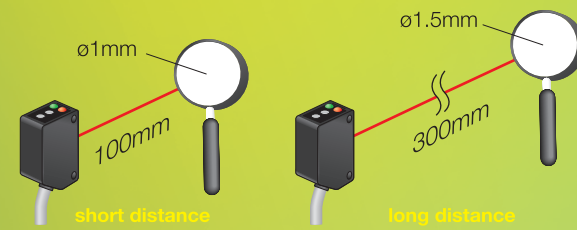

250 μ sec response

Good for fast moving objects.

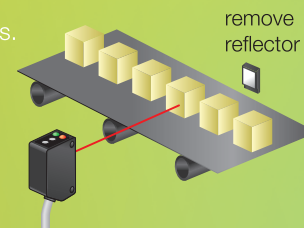

External control of Laser Beam

External control of laser OFF is possible by connecting gray wire to GND (NPN type) or DC10-30V (PNP type).



BGS optical system designed with Laser light source

Extremely small BGS type sensors are only 20 x 11 x 31mm. Ideal for use in OEM equipment such as Printed Circuit Board processing machines.

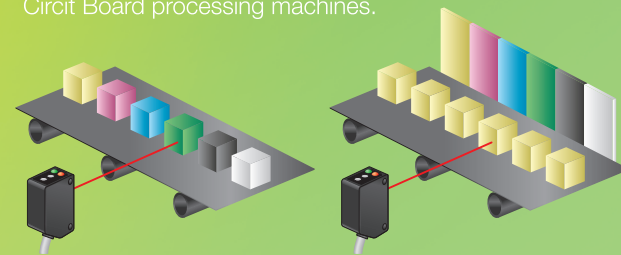

Large projected spot size

The LED version of the BGS sensors projects a large 6 mm spot that will not be affected by small holes in a PC board. For PC boards that may have larger holes, the BGS-Z30 has an 18 mm projected spot size.

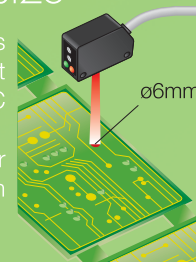

4 Turn adjustment pot.

A four turn adjustment pot. is built-in for precise adjustment of the sensing distance. The potentiometer has a slip clutch that protects it from damage when it is turned past the end.



Specifications

Model	long distance		short distance		long distance		short distance		
	2m Cable	M8QD 4pin	2m Cable	M8QD 4pin	2m Cable	M8QD 4pin	2m Cable	M8QD 4pin	
Type	NPN	BGS-ZL30N	BGS-ZL30CN	BGS-ZL10N	BGS-ZL10CN	BGS-Z30N	BGS-Z30CN	BGS-Z10N	BGS-Z10CN
	PNP	BGS-ZL30P	BGS-ZL30CP	BGS-ZL10P	BGS-ZL10CP	BGS-Z30P	BGS-Z30CP	BGS-Z10P	BGS-Z10CP
Setting distance	50 - 300 mm (*1)		20 - 100 mm (*1)		50 - 300 mm (*1)		20 - 100 mm (*1)		
Sensing distance	10 - 300 mm (*1)		5 - 100 mm (*1)		10 - 300 mm (*1)		5 - 100 mm (*1)		
Response time	250 μ s		500 μ s		500 μ s		500 μ s		
Spot size	ϕ 1.5mm/300mm		ϕ 1mm/100mm		ϕ 30mm/300mm		ϕ 10mm/100mm		
Hysteresis (white to white)	5%		3%		5%		3%		
Output Operation	Light On / Dark On selectable				Light On / Dark On selectable				
Output Indicator	Output : orange, Laser Power : green				Output : orange, Stable : green				
Sensitivity adjustor	4-turn, endless pot.				4-turn, endless pot.				
Control Output	NPN or PNP open collector, 100mA max / DC30V				NPN or PNP open collector, 100mA max / DC30V				
Supply Voltage	DC 10 - 30V, including 10% ripple				DC 10 - 30V, including 10% ripple				
Power consumption	30mA max				30mA max				
Protection Category	IP 67				IP 67				
Shock resistance	50G				100G				
Environmental Temp/Humid	- 10 to 55°C / 35 to 85% RH				- 25 to 55°C / 35 to 85% RH				
Materials	Housing : ABS with glass, Lens : PMMA				Housing : ABS with glass, Lens : PMMA				

*1 = white paper 100 X 100mm

Specifications are subject to change without prior notice.

Retro-Reflective with Coaxial LED

The best for transparent Plastic / Glass detection

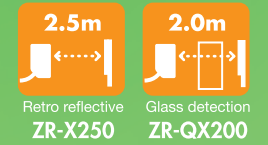

- Coaxial LED source gives extremely tight alignment to the target. Alignment of sensor is easy thanks to bright projected LED spot.
- 250 μ sec fast response (ZR-X, coaxial beam type)
- World's standard model ZR-Q (general type) and ZR-QX (coaxial beam type) for Plastic and Glass applications.

Zero dead area!

The sensor has no dead area in the sensing field. This makes it ideal for use on conveyors where the position of the target changes.

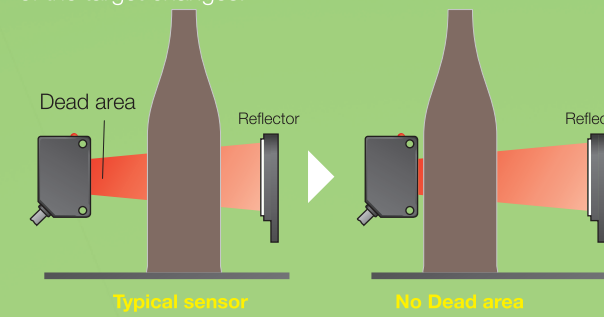

Repeat Accuracy

Very tight Repeat Accuracy, 0.2 - 0.3mm for BGS type. Even Thru-beam and Retro types have 0.3mm Repeat Accuracy(*).

*=Tested at the middle point of sensing range.

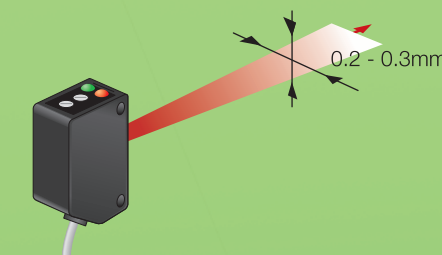

Good selection of sensors for various types of bottles.

Glass and plastic bottles come in various shapes / sizes and with many different contours which require testing in the field to determine the best sensor for the application. The Z series is offered with both Co-axial and Conventional LED light sources to provide a solution for the detection of any bottle type.



Coaxial LED

Coaxial LED light source provides extremely tight alignment to the target, Alignment of sensor is very easy thanks to bright projected LED spot.



Specification

Model	Retro Reflective for Transparent				Polarized Retro-refle ctive (Coaxial Beam)		
	General Use		Coaxial Beam		2m Cable	M8QD 4pin	
Type	NPN	ZR-Q200N	ZR-Q200CN	ZR-QX200N	ZR-QX200CN	ZR-X250N	ZR-X250CN
	PNP	ZR-Q200P	ZR-Q200CP	ZR-QX200P	ZR-QX200CP	ZR-X250P	ZR-X250CP
Sensing range	0.01 - 2 meter (V-61 reflector)		0 - 2 meter (P250F reflector)		0 - 2.5 meter (V-61 reflector)		
Response time	0.5 msec				250 μ s		
Spot size	ϕ 300mm/at 2m		ϕ 60mm/at 2m		ϕ 60mm/at 2m		
Output Operation	Light On / Dark On selectable				Output : orange, Stable : green		
Output Indicator	Output : orange, Stable : green		Output : orange		Output : orange, Stable : green		
Sensitivity adjustor	1-turn pot.						
Control Output	NPN or PNP open collector, 100mA max / DC30V						
Supply Voltage	DC 10 - 30V, including 10% ripple						
Power consumption	20mA max						
Protection Category	IP 67						
Shock resistance	100G						
Environmental Temp/Humid	- 25 to 55°C / 35 to 85% RH						
Materials	Housing : ABS with glass, Lens : PMMA						

Specifications are subject to change without prior notice.

LED Type For General Use

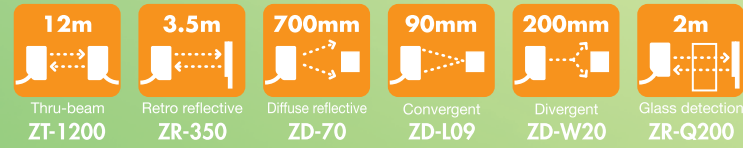

- 100G shock resistance, IP67 rating. Tough sensor !
- ZR-Q series, ideal for detection of PET bottles, transparent objects, etc.
- Standard models for cost savings.

500μsec response

Good for fast moving objects.

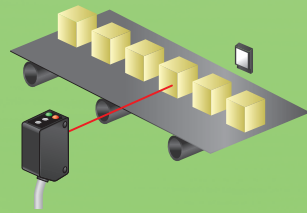

Cross-talk prevention

With built-in cross-talk prevention, it is possible to mount two sensors side-by-side without mutual interference.

(Use part number BL-100-POLF for thru-beam type sensors.)



ZD-W20 application

The Divergent type ZD-W20 provides a wide angle beam that can be used to detect transparent film by collecting the reflected light from the material surface.

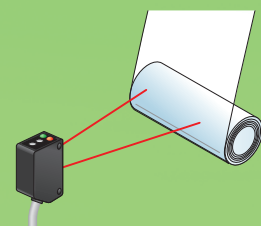

IP67 rating

Hose it down!
Water-tightness is tested to IP67.



Rugged 100g shock rating.

Rigid design for high resistance to mechanical shock

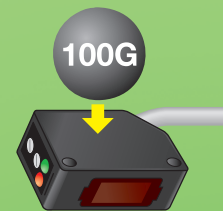

Threaded mounting holes

Prevents sensor from being damaged when it's mounted.



Specification

Model	Thru-beam	Polarized Retro-reflective	Diffuse-reflective	Convergent	Divergent	Glass detection	
Cable type	NPN	ZT-1200N	ZR-350N	ZD-70N	ZD-L09N	ZD-W20N	ZR-Q200N
	PNP	ZT-1200P	ZR-350P	ZD-70P	ZD-L09P	ZD-W20P	ZR-Q200P
M8 connector type	NPN	ZT-1200CN	ZR-350CN	ZD-70CN	ZD-L09CN	ZD-W20CN	ZR-Q200CN
	PNP	ZT-1200CP	ZR-350CP	ZD-70CP	ZD-L09CP	ZD-W20CP	ZR-Q200CP
Sensing range	12 m	3.5m (V-61 reflector)	70cm	1-9 cm	0-200 mm	2 m (V-61 reflector)	
Response Time	0.5 msec						
Spot size	1.5m @ 12 meter	350mm @ 3.5 meter	100mm @ 700mm	12mm @ 90mm	60mm @ 50mm	300mm @ 2 meter	
Output Operation	Light On/Dark On selectable						
Hysteresis	NIL		20% Max	10% Max	20% Max	NIL	
Light source	Red LED						
Sensitivity adjuster	1-turn trimmer (240 degree)						
Control Output	NPN or PNP Open collector, 100mA Max / 30V DC						
Supply Voltage	DC 10 - 30V incl. 10% ripple						
Regulation	JIS/C4525, CE, CUL, VDE						
Power consumption	20mA Max						
Indicator	Dual Indicator (Output : orange, Stable : green)						
Protection Category	IEC 144 IP67, VDE level 3						
Shock resistance	100G (1,000m/S ²)						
Environment Illumination	Sunlight : 10,000 lux Max., Incandescent lamp : 3,000 lux max.						
Materials	ABS with glass fiber (Case), PMMA (Lens)						

Specifications are subject to change without prior notice.

Dimensions (mm)

General Use Types except BGS

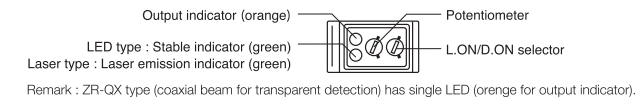

Remark : ZR-QX type (coaxial beam for transparent detection) has single LED (orange for output indicator).

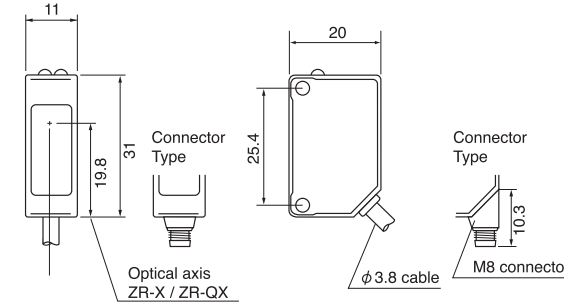

<Cable>

Brown : DC10~30V
Blue : GND
Black : Control Output
Gray : Laser Stop *Laser type only
(NPN connect to GND / PNP connect to DC10~30V)

<4 Pin configuration>

① DC10~30V
② Laser Stop *Laser type only
(NPN connect to GND / PNP connect to DC10~30V)
③ GND
④ Control Output

BGS Types

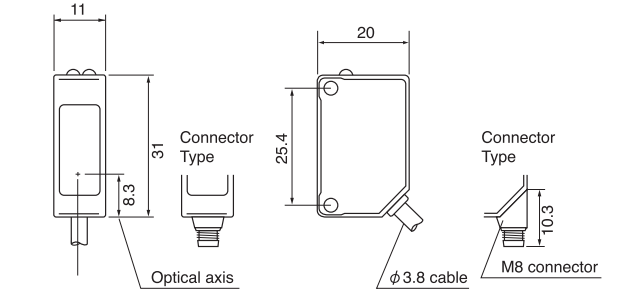
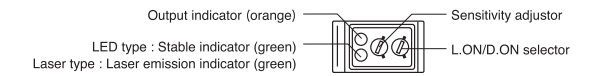

Options

Reflectors for LED Type

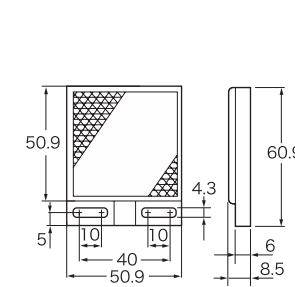

Standard reflector V-61
(Standard, LED type)

Reflectors for Laser Type

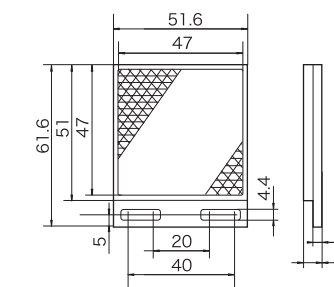

P250F
(Standard, Laser type)

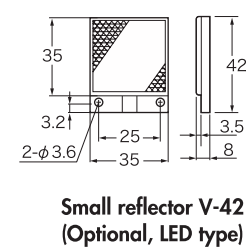

Small reflector V-42
(Optional, LED type)

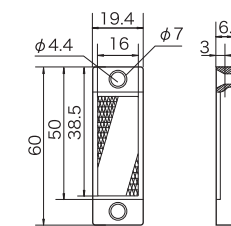

PL20F
(Optional, Laser type)

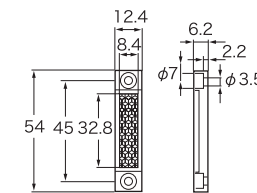

Tiny reflector P-45
(Optional, LED type)

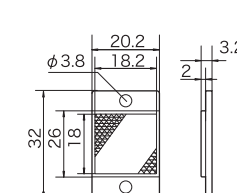

PL10F
(Optional, Laser type)

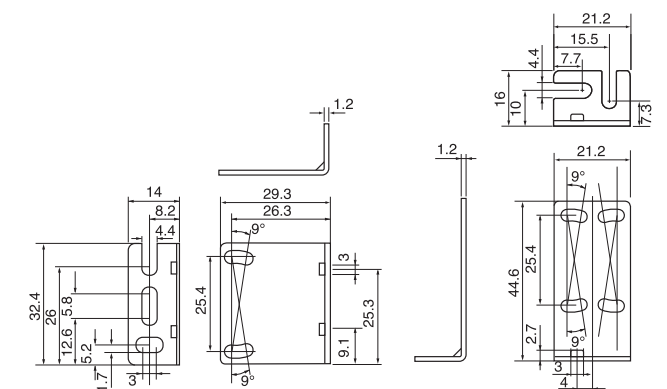

Standard bracket
BEF-W-100-A
Accessory for M8 QD type sensors

Standard bracket
BEF-W-100-B
Accessory for cabled type sensors

Type	Size	Attached to	Object size (Min)	Scanning range
Slit a	0.5mm	Receiver/Emitter	0.4mm	0.8mm
Slit B	1mm	Receiver/Emitter	0.6mm	2.5mm
Slit C	2mm	Receiver/Emitter	1.5mm	5mm

Slit mask BL-160-SK (for Thru-beam type)



JCN-S : M8 Straight type

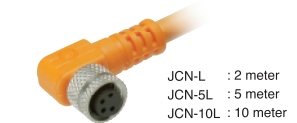

JCN-L : L-shape M8 type



BL-100-POLF Cross-talk prevention filter for ZT-1200